

Contents

- 07 Cabinets
- 47 Vanities
- 57 Closet System
- 60 About Hassem
- 62 Hanssem Advantages
- 64 Technology & Craftsmanship
- 66 Materials & Cabinet Construction
- 70 Door Styles, Designs & Finishes

Everyday is Special with Hanssem.

When it comes to cabinet making, nothing is more important than wood. Our commitment begins with using only the finest natural woods and wood materials for your cabinets. We hand select the most beautiful natural wood, skillfully sorting the variation of graining and hue. We proudly manufacture in New Jersey, USA, and source our wood materials domestically and globally.

At Hanssem we take pride in offering the solutions necessary to make your dream home a reality. Hanssem manufactures kitchen and bathroom cabinetry as well as closet systems. Whether it's framed or frameless; hand-stained or painted, stock or custom-sized, we have all the details you desire. Experience what Hanssem has to offer where the possibilities are endless!

Cabinets

American Classic
/ Framed

Irvine

Jacksonville

Illinois

Hudson







Irvine

Maple / Charcoal Gray

FLAT CENTER PANEL

5-pc, Tenon Door, 2 1/4" Frame, Eased Edge. Calgary Bead, 1/4" Veneer Center Panel.

DOOR PROFILE



Framed Open Shelf



Blind Corner Base Cabinet with Wood Half Moon Susan



Utilize every square inch of your space with pull-out organizers and blind corner base cabinets.

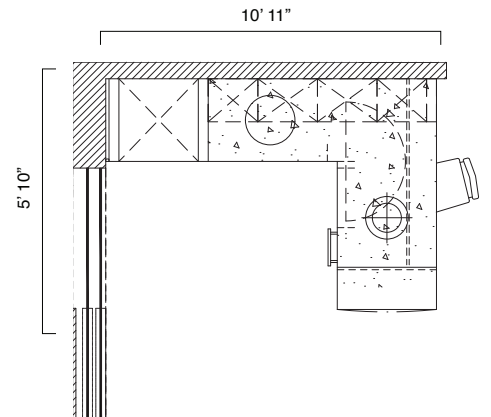







Jacksonville

Maple / Frosty White

FLAT CENTER PANEL

5-pc, Tenon Door, 3" Frame
Eased Edge Wide Slant Bead
1/4" Veneer Center Panel

DOOR PROFILE



Cutlery Divider



Add a modern flair to make your kitchen a multi-functional space with an all-inclusive island and workstation.

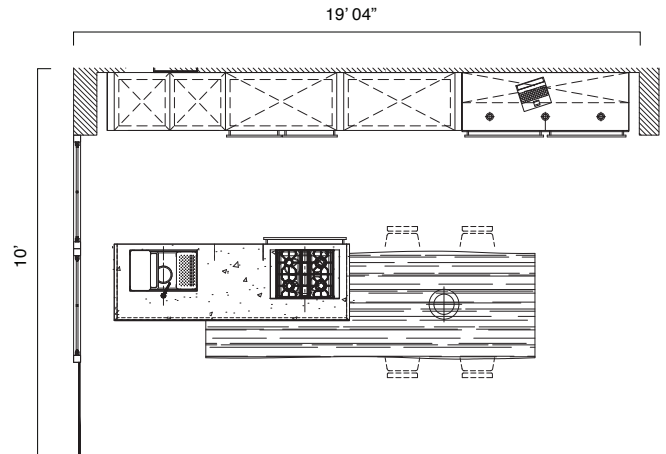







Illinois

Maple / Gray

FLAT CENTER PANEL

5-pc, Shaker Door

2 1/4" Frame, Eased Edge

Deep Bevel Bead, 1/4" Veneer Center Panel

DOOR PROFILE



Pull-out Organizer



Utility Cabinet with Rollout Shelves



Crisp style and pull-out storage convenience ensures a subtle mixture of traditional and modern lifestyle.

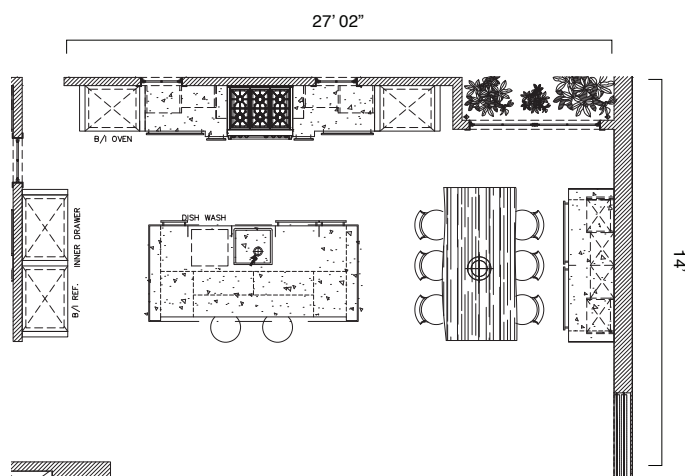







Hudson

Maple / Frosty White

FLAT CENTER PANEL

5-pc, Shaker Door
2 1/4" Frame, Eased Edge
1/4" Veneer Center Panel

DOOR PROFILE



Cutlery Tray and Pegboard





Hudson is a classic shaker door style. Add a functionality to the classic home style kitchen with Cutlery Tray and Pegboard.

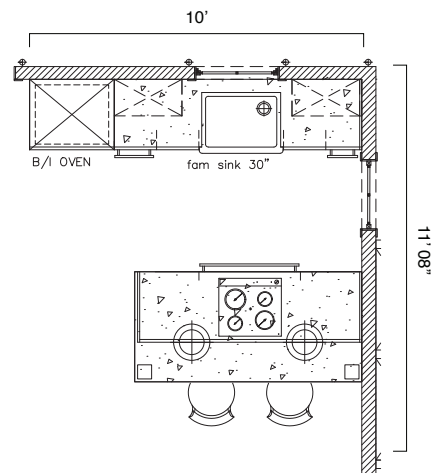

Cabinets

Euro / Full Access

Florence

Isabel

Iowa

Jefferson

Harrisburg







Florence

PET / White Gloss

FLAT PANEL

Particle Board Core

PET Front & Melamine Back

with Coordinating 1.2mm Edge Band

DOOR PROFILE



Cutlery Tray & Pegboard



Appreciate style with state-of-the-art edge banded doors that have a light-reflecting high gloss white finish for a sleek, modern look.

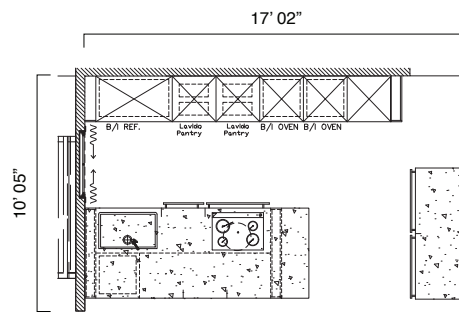







Isabel

Maple / Blue

FLAT CENTER PANEL

5-pc, Shaker Door
2 1/4" Frame, Eased Edge
1/4" Veneer Center Panel

DOOR PROFILE



Cutlery Tray



Chrome Magic Corner Base Cabinet



Bring a new twist to a traditional style with a wide variety of paint doors. Our finishes are skillfully applied multiple times including robotic top coating process resulting in a smooth and durable surface.

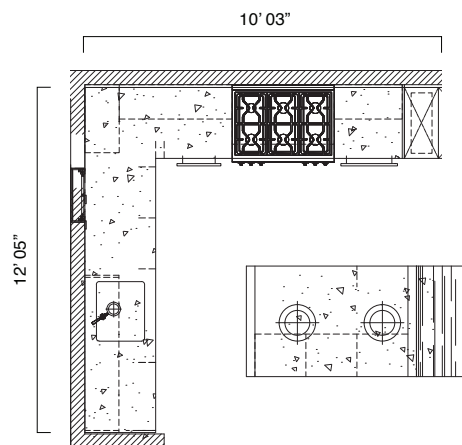







Iowa

Maple / Mist

FLAT CENTER PANEL

5-pc, Shaker Door
2 1/4" Frame, Eased Edge
1/4" Veneer Center Panel

DOOR PROFILE





There are no two trees alike. The true beauty of wood is in its natural variations of graining and hue. Our artisans use a hand-wiping process that stains the wood and enhances the natural beauty in your space.

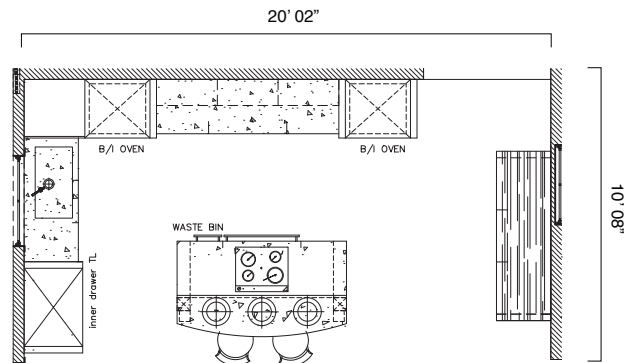







Jefferson

Maple / Crystal White

RAISED CENTER PANEL

5-pc, Solid Wood Door
2 1/4" Frame, Eased Edge
Square Raised Panel

DOOR PROFILE



Wood Spice Drawer Insert and Cutlery Tray



Find the delicate texture of a raised center panel that comes from exquisite craftsmanship. We select the finest solid wood and hand-sand each door to create the classic silhouette of Jefferson door.

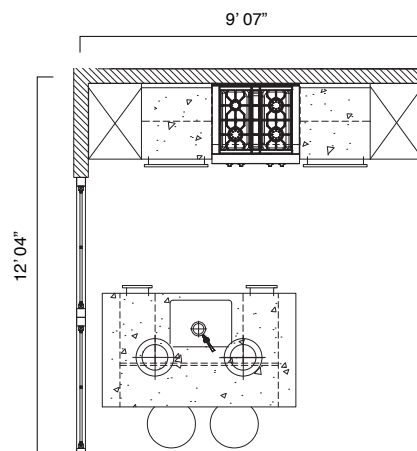





Harrisburg

MDF / Frosty White

FLAT PANEL

Slab Door, Eased Edge
MDF Core with Coordinating PVC Edge

DOOR PROFILE



Pull-Out Base Organizer



Harrisburg is made with quality processed wood for lasting durability and design features. Create your own design with our endless modification options.

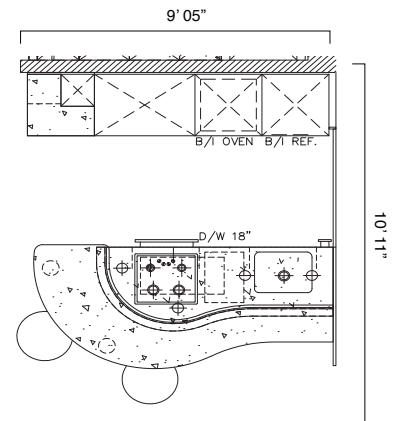

Vanities

Bathroom & Powder Room

Hudson

Florence

Kelly



Hudson

Maple / Frosty White

FLAT CENTER PANEL

5-pc, Shaker Door
2 1/4" Frame, Eased Edge
1/4" Veneer Center Panel

DOOR PROFILE



Our steady selling door, Hudson, comes in Frosty White and gives a sleek, minimalistic style to your room. Bring your dream bathroom into reality with any style for any space.







Hudson

Maple / Natural

FLAT CENTER PANEL

5-pc, Shaker Door
2 1/4" Frame, Eased Edge
1/4" Veneer Center Panel

DOOR PROFILE



If you have a master or powder room, having a luxury vanity will turn your space into a whole new world. It also has a lot of drawers of various sizes for storing personal items. Keep your space tidy and organized with your vanity base.



Florence

PET / White Gloss

FLAT PANEL

Flat Panel, Particle Board Core,
PET Front & Melamine Back with
Coordinating 1.2mm Edge Band

DOOR PROFILE

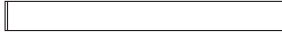

Wall mount vanity also called floating vanity gives the illusion of more floor space which gives a more spacious look to your bathroom. Wall mount vanity allows you to make the most of your available space and provides both visually stunning and efficient storage space.





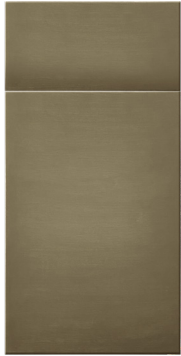

Kelly

Rift Cut Oak / Mist

FLAT PANEL

Slab Door

Flat Horizontal Grain Veneer Door

.5mm Edge Banding

DOOR PROFILE



One of the most wished for and enjoyed elements in the master bath is a double sink vanity that adds something interesting to the overall aesthetic of any bathroom. Styles, designs, finishes, and materials know no bounds. From wood to manufactured wood, you can discover that one perfect bathroom vanity to enhance your very own dream bath.

Closet System

Launching in 2021





About Hanssem



Our Story

We're an international corporation recognized as a premier cabinet manufacturer. While we are headquartered in South Korea, we locally and globally source wood materials and manufacture our cabinets in New Jersey, USA. Over the past 30 years, Hanssem has established a network of over 500 independent dealers from Boston to Florida.



Our Commitment

Our commitment to quality begins with using only the finest materials and hardware for products. We blend highly advanced manufacturing technologies and automation with the skills of an experienced craftsmen to create a truly unique approach to cabinet making.

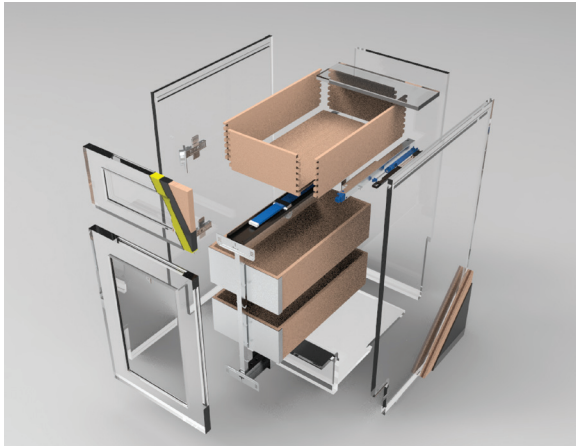

Our Standard

We strive to deliver beyond your expectations. There is no need to “upgrade” your cabinets for a better quality. With all cabinets plywood construction, wood dovetail drawer boxes and soft-closing runners and hinges made by Blum, the leader in the hardware industry set our cabinet quality as standards.



Our Promise

Your experience with Hanssem doesn't end with high-quality standards. We provide a wide range of door styles, colors, sizes, and more. Not only that, all of our cabinets are backed with Limited Lifetime Warranty which will ensure lasting impressions. Dream outside the limits. With Hanssem, you can make it happen.

Hanssem Advantages

We manufacture all cabinetry in our Edison, NJ, plant using state-of-the-art machinery and finishing systems. We use the finest materials from the industries leading European and North American suppliers and combine them with over 30 years of manufacturing expertise to bring our customers the finest quality cabinets available today.



Made in the USA

All our cabinets are proudly manufactured in the USA with domestically and globally sourced EPA certified wood. All wood-working and assembly of our cabinet is done at our facility in Edison, New Jersey.



Higher Standards - The Hanssem Difference

All cabinets are constructed using durable 3/4" plywood tops, bottoms, and sides, wood dovetail-cornered drawer boxes, and soft-closing runners and hinges made by Blum®, a leader in the hardware industry.



Advanced Technology & Quality Craftsmanship

Our cabinets go through extensive processes to end with a high-quality finished product. We use state-of-the-art machinery and hand craftsmanship to ensure consistent cabinet structure.



Limited Lifetime Warranty

We ensure all of our products meets customer satisfaction and excellence with a Limited Lifetime Warranty. Don't worry about long-term quality with us.



100% Modification with a Great Value Price

Endless modification options are available to you at a great value price. From styles of doors to finishes, we can help you create your dream kitchen, however you'd like.



Delivery Service

We have our own warehouse where we can manage the entire production process of our cabinets and provide jobsite delivery service for our local dealers.

Advanced Technology & Quality Craftsmanship

Our products are crafted by skilled cabinet makers using proven construction methods and innovative manufacturing techniques. We create beautiful, high-quality, American-made cabinets using environmental friendly woods that will stand the test of time.



We Set New Standards

Our special "T Joint" construction method and upgraded cabinet construction standards have resulted in durable, American made cabinets people value.



It's All About Detail

Skilled cabinet makers carefully select which wood to use. These craftsmen add details and artistic appeal to any finish, that creates a rich look for every style.



Advanced Automation System

We use highly advanced automation for consistency, precision, and speed. State-of-the-art edge banders, CNC routers, finish spray machines, and panel saws add to the superiority of the finished product.



Skilled Artisans

The quality of our cabinet is a top priority. Our cabinets are individually built to make sure they are the best quality. Each door and drawer are thoroughly inspected to meet our high expectation before being shipped to the jobsite.

Materials & Cabinet Construction

Materials Origins

We believe in building an authentic relationship with our customers is important. Our customers learn essential insights into our products and construction process.

Wood

Mapleton Particle Board	USA
White Melamine	USA
Plywood	USA, Vietnam, Cambodia
Laminate	USA(Wilson Arts/Formica), Canada (Formica/Tafisa)
Thermofoil	USA, Germany, Japan
Maple, Cherry, Rift Cut Oak	USA

Finish

Paint	USA (Sherwin-Williams)
Stain	USA (Sherwin-Williams)
Top Coat	USA (Sherwin-Williams)

Parts/Adhesive

Edgeband	USA, Canada
Glues	USA
Packaging	USA
Hinges	USA (Blum®), Austria (Blum®)
Runners	USA (Blum®), Germany (Hettich®)
Aluminum	USA
Door Bumper	USA

Our Environmental Sustainability

Manufactured in the USA
with CARB2 Compliance



At Hanssem, we support your healthy and sustainable lifestyles with green cabinetry options from Hanssem. We are committed to make sure all of our products meet applicable environmental standards. Our products are CARB2 compliant which means the products comply with the regulations set by the California Air Resources Board (CARB) and United States Environmental Protection Agency (EPA) to have extremely low formaldehyde content and protect the public from airborne toxic contaminants.

Our Partnerships



Standard Cabinet Specifications

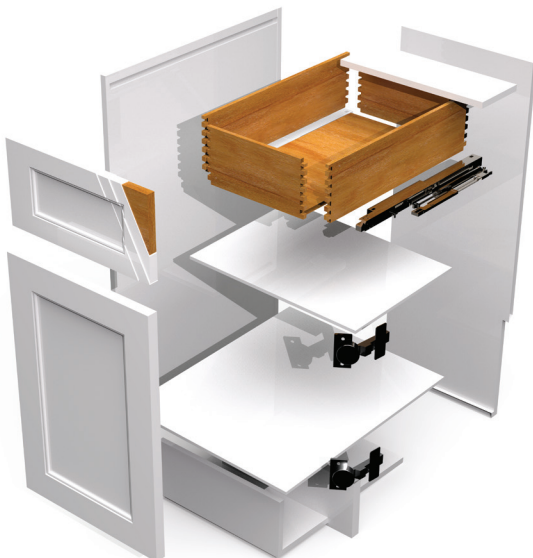

We strive to deliver beyond your expectations. There is no need to “upgrade” your cabinets for a better quality. All plywood construction, Blum® soft-close runners and hinges, wood dovetail drawer boxes, and other features come standard with Hanssem cabinets.

Side, Top & Bottom Panel: ¾” thick clear coated plywood

Back Panel: ¼” clear coated plywood

Shelves: ¾” clear coated plywood

Toe Kick, Open Cabinet & Cabinets with Finished Interior: Matching color on plywood

Drawer Box & Runner: Blum® soft close full extension / wood dovetail

Hinges: Blum® soft close hinge

Small/Large Drawer Front: Matching

Front Edge Band: PVC coordinating with door

Natural Wood

Natural wood doors are made from trees growing in different environments and conditions. This results in the tree having naturally varying grains and sap wood. Other imperfections such as burls, pecks, shakes, knots and mineral streaks also occur in natural woods.

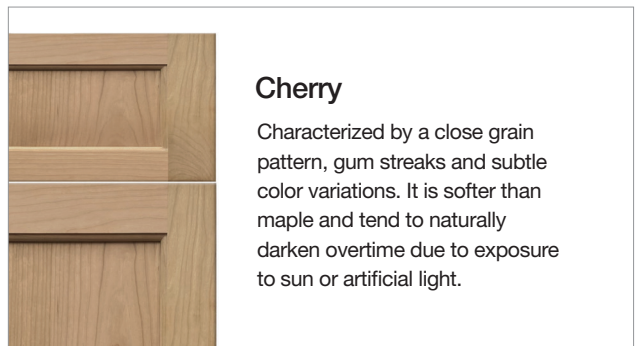
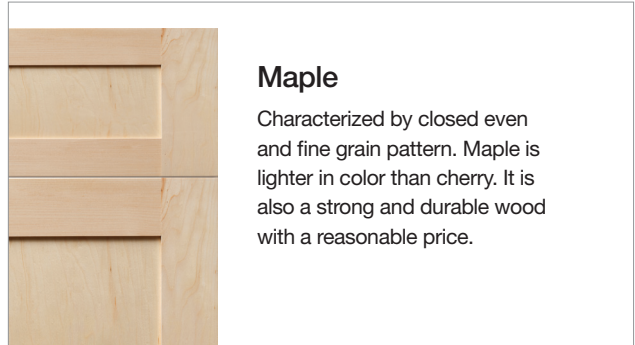

Manufactured Wood

Manufactured wood products known as substrates are hidden behind laminate, vinyl film, or wood veneers.

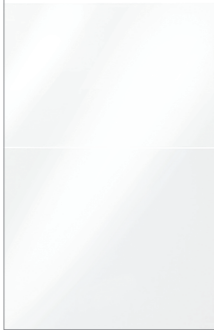

Lacquer
Made by applying several coats of high quality lacquer/ paint to the MDF base.



Colortone on MDF
Colortones are pigmented base coats that are similar to paint. It is finished with a clear coat conversion varnish.

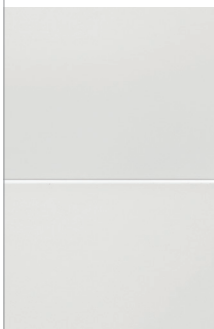

Laminate
A surface material that is made from paper and resin being pressed and glued together. They are the most durable and easiest to clean.

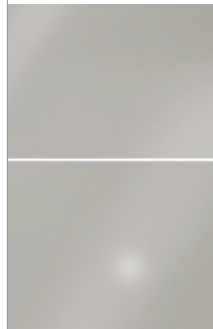

PET / Textured Melamine
Particle Board Core with PET Front & Melamine back or PB Core with Textured Melamine front & back.



Thermofoil
A flexible vinyl material that is applied by heating the vinyl and molding it over medium-density fiberboard. These doors are easy to clean, durable and offer many design options.



Aluminum Framed Glass
Characteristically lightweight and has high reflectivity, enhancing the illumination in your home.

Door Styles & Designs

Door Styles



Flat

Slab style door without a raised or recessed panel. Perfect Match for both traditional and contemporary looks.



Tenon

Tenon door is considered one of the strongest woodworking joints for attaching two pieces of wood at 90 degrees.



Miter

Beautiful mitered door assembled by cutting the stiles and rails at a 45-degree angle.



Shaker

Features a flat center panel and square edges. With minimal detailing, shaker is one of the famous door styles.



Molding

From simple to ornate, classic to modern, add an accent with the decorative molding door.

Door Designs

Framed | American Classic
Full Access | Euro

Flat Center Panel



FREESIA
Foil | Latitude East
Full-Access Only



FARMINGTON
Maple | Frosty White
Full Access Only



HUDSON
Maple | Frosty White



HANOVER
Cherry | Cinnamon



HAMPTON
MDF | Frosty White

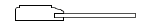

HYACINTH
Maple | Lunar Gray



ISABEL
Maple | Blue



ILLINOIS
Maple | Gray

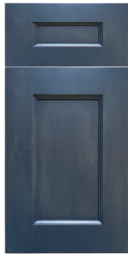

IRENE
Maple | Denim



IRIS
Maple | Gray



IRVINE
Maple | Charcoal Gray



INDIANA
Maple | Blue



IOWA
Maple | Mist



IDAHO
Maple | Natural



IMMANUEL
Cherry | Walnut Brown



IMPERIAL
Cherry | Colonial



JERSEY
Maple | Natural

Flat Center Panel
Continued



IRVINGTON
Maple |
Crystal White



INGLEWOOD
Maple |
Charcoal Gray



JACKSONVILLE
Maple |
Frosty White



JULIA
Maple |
Harvest Gold

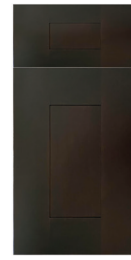

KANSAS
Maple | Sepia

Flat Door
Full Access Only

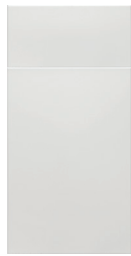

DAVIS
Laminate | White &
PVC Square Edge

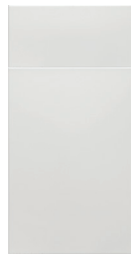

DAVIS UNO
Laminate | White &
Silver Metallic Edge



DAYTON
Textured Melamine
| White Chocolate



DAISY
Textured Melamine
| South Wester

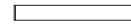
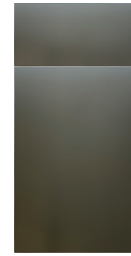

DENNIS
PET | Gray Matte

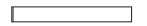

FLORENCE
PET | White Gloss

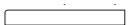

FLORIDA
Foil | Wenge



FAIRFIELD
Foil | Satin White

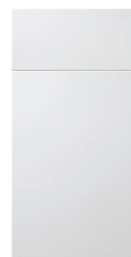

HARRISBURG
MDF | Satin White
Both Framed & Full
Access

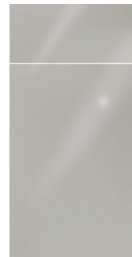

ISAAC
Lacquer | Gray
Gloss & Two Tone
Edge



ISAAC UNO
Lacquer | Burgundy
Gloss & Silver
Metallic Edge



KENNEDY
Maple | Denim
Both Framed &
Full Access



KELLY
Maple | Mist

Raised Center Panel



HARTFORD
MDF |
Frosty White

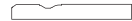

FRANKLIN
Foil | Satin Antique
White
Full Access Only



JEFFERSON
Maple |
Crystal White



JESSICA
Cherry | Colonial



JASMINE
Cherry |
Walnut Brown
Framed Only



JANE
Cherry | Sepia
Framed Only



KENSINGTON
Maple |
Frosty White



KEYPORT
Cherry | Cordovan

Molding Door



KINGSTON
Maple | Cinnamon



KATHERINE
Maple | Walnut
Brown

Aluminum Door

Full Access Only



KATE
Glass | Square
Frame



KAILA
Glass | Concealed
Frame

Door Finish

Glaze and Hightlight options are also available.
Actual product colors may vary from colors shown on here.
We strongly recommend you to view an actual product sample.

Maple



MESA



NATURAL



HARVEST
GOLD



COLONIAL



CINNAMON



STONE



MIST



DENIM

PREMIUM COLORS

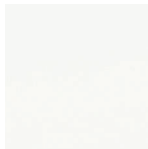

FROSTY
WHITE

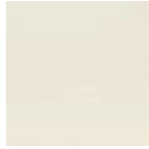

CRYSTAL
WHITE

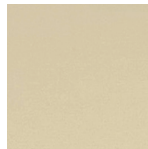

CHESAPEAKE



GRAY



LUNAR GRAY

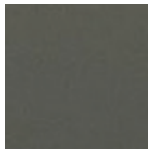

CHACOAL
GRAY



BLUE

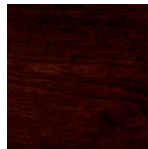

SEPIA



COFFEE

Colortone on MDF

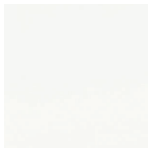

FROSTY
WHITE

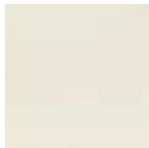

CRYSTAL
WHITE

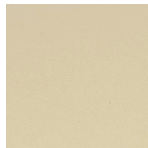

CHESAPEAKE



GRAY

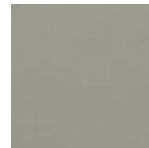

LUNAR GRAY

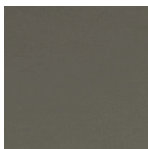

CHARCOAL
GRAY



BLUE

Cherry



HARVEST
GOLD

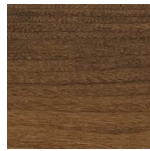

COLONIAL



CINNAMON



CARMEL

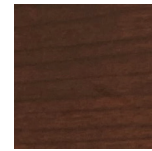

CORDOVAN



WALNUT
BROWN



STONE



MIST



DENIM

PREMIUM COLORS

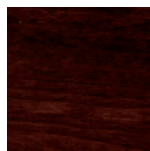

SEPIA



COFFEE

Rift Cut Oak

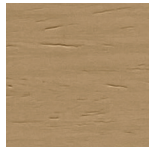

MESA



NATURAL



HARVEST
GOLD



AMBER

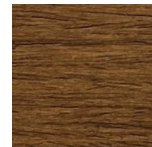

COLONIAL

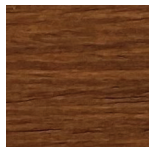

CINNAMON

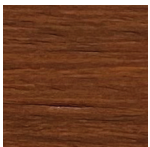

CARMEL

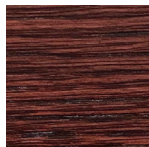

CORDOVAN

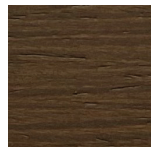

WALNUT
BROWN

PREMIUM COLORS

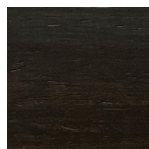

SEPIA

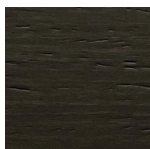

COFFEE

Thermofoil

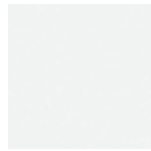

WHITE



BRUSHED
WHITE

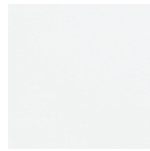

SATIN WHITE



SATIN
ANTIQUÉ
WHITE



BRUSHED
ALUMINUM



FASHION
GRAY



LATITUDE
EAST

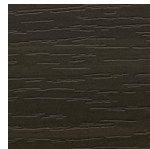

WENGE

PREMIUM COLORS

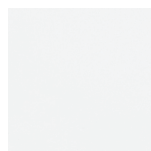

HG WHITE



HG ANTIQUÉ
WHITE

PET / Textured Melamine

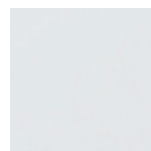

WHITE
GLOSS



GRAY
MATTE



WHITE
CHOCOLATE



SOUTH
WESTER

Lacquer



GRAY
GLOSS



BURGUNDY
GLOSS

Limited Lifetime Warranty

This warranty is provided to the original consumer purchaser, starting from the Hanssem Dealer's original date of purchase. The lifetime of cabinets is expected to be 10 years. Based on all other warranty terms and conditions being met, warranty claims will be prorated based on the expected lifetime of the product.

What does this Limited Lifetime Warranty cover?

Hanssem warrants its "covered products" to the original consumers for ten years to be free from all defects in workmanship and materials under normal residential use. Covered products include cabinet boxes, doors, drawers, shelves, and accessories manufactured by Hanssem. This warranty explicitly excludes any items not manufactured by Hanssem that may be sold with the cabinets.

Hanssem will replace defective covered parts for the original consumers free of charge during the warranty period. Hanssem will not pay any expenses related to the removal, or reinstallation of the covered part. After inspection, Hanssem will replace or repair a covered part at its discretion. If the specific product is no longer available Hanssem reserves the right to supply a "best match" alternative.

Component Pass-Through Warranty

Although Hanssem does not warrant components, it will pass through any warranties received by component suppliers, to the extent permitted by such component suppliers.

Replacement hinges, drawer slides, and other accessories are subject to availability from our suppliers. If a claim is filed after a product becomes obsolete, the manufacturer will replace the discontinued product with a similar and comparable product to the original.

What is not covered?

This Warranty is limited to defective parts replacement and does not include labor or damage incurred during installation, removal, storage, handling, repair, or replacement. Hanssem cabinets purchased prior to **2021 April** are not covered by Hanssem's Limited Lifetime Warranty.

The Limited Lifetime Warranty does not apply to goods or any parts that have been subject to accident, negligence, alteration,

abuse, or misuse. Hanssem also does not warrant Express, Implied or Statutory, any accessory or parts NOT manufactured by Hanssem.

This warranty does not apply to Thermofoil, Acrylic, Laminate, or Melamine products that discolor, delaminate or bubble if installed without the use of properly installed heat shields adjacent to appliances or fixtures such as ovens or lights that generate high temperatures. These warranties do not apply to cabinetry ordered and purchased unfinished.

Also, natural woods vary in color and characteristics and exhibit subtle changes as they age. Wood doors are made from trees growing in different environments and conditions. This results in naturally occurring such as variation in color, grain, mineral streaks, pinholes which are not considered defects. Also, cabinet colors darken or lighten over time due to sunlight, smoke, household cleaners, and other environmental conditions. Painted doors may eventually have visible cracking around the joint areas. These variations are not considered defective and will not be replaced under Hanssem's Warranty.

These warranties are the exclusive warranties of Hanssem and are in lieu of all other warranties, expressed or implied, including the implied warranties of merchantability and fitness for a particular purpose.

This warranty is non-transferable but gives the original consumer specific legal rights. You may also have other rights that vary by state.

How Do You Obtain Warranty Service?

To obtain performance under these Limited Warranties, first contact your authorized Hanssem dealer, who will arrange for an inspection. A dated sales receipt as proof of purchase is required to obtain benefits from these warranties. If a dealer is unavailable, please contact our Customer Service Department.

In keeping with our policy of continuous product improvement, we reserve the right to change product specifications without notice.

* Warranty for Contract Orders as per contract terms.

This warranty excludes all industrial, commercial and business usage.

Contact Us



Corporate Headquarter

HANSSEM US
20 Kilmer Road
Edison, NJ 08817
United States

EMAIL
marketing@hanssemus.com

PHONE
908. 754. 4949

WEB
www.hanssemus.com

BACK COVER
INSIDE